

DATE	REV	EON	APP'D. BY
1-15-07	B2	7898	TRM
6-25-09	B3	8769	JM
2-14-11	B4	9128	TRM
5-23-12	B5	9477	SMN

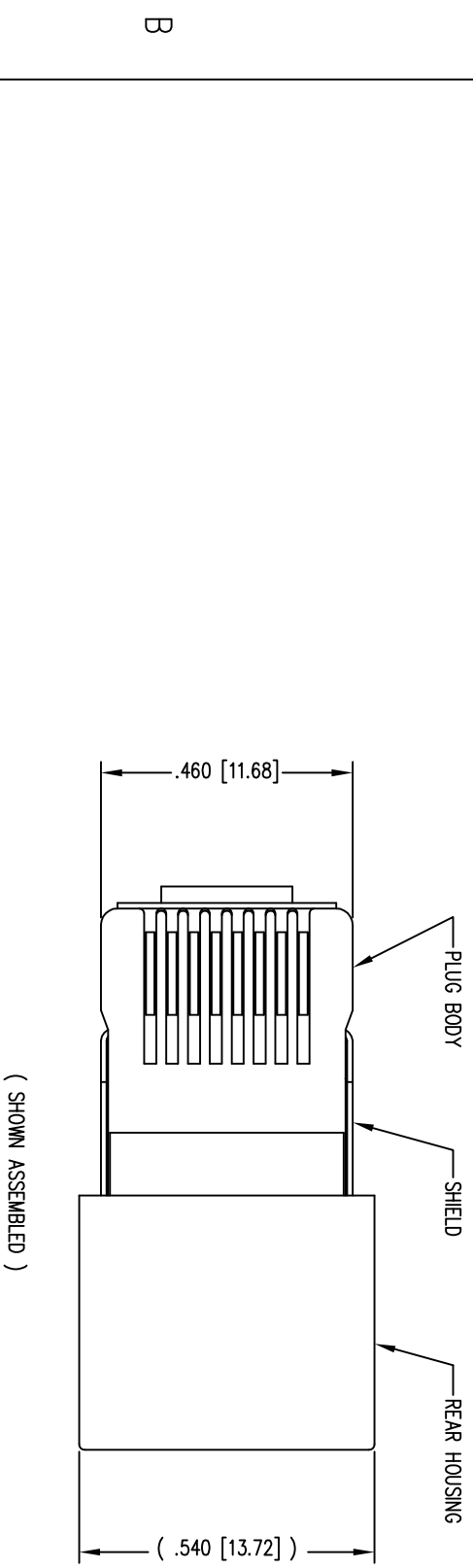

B

B

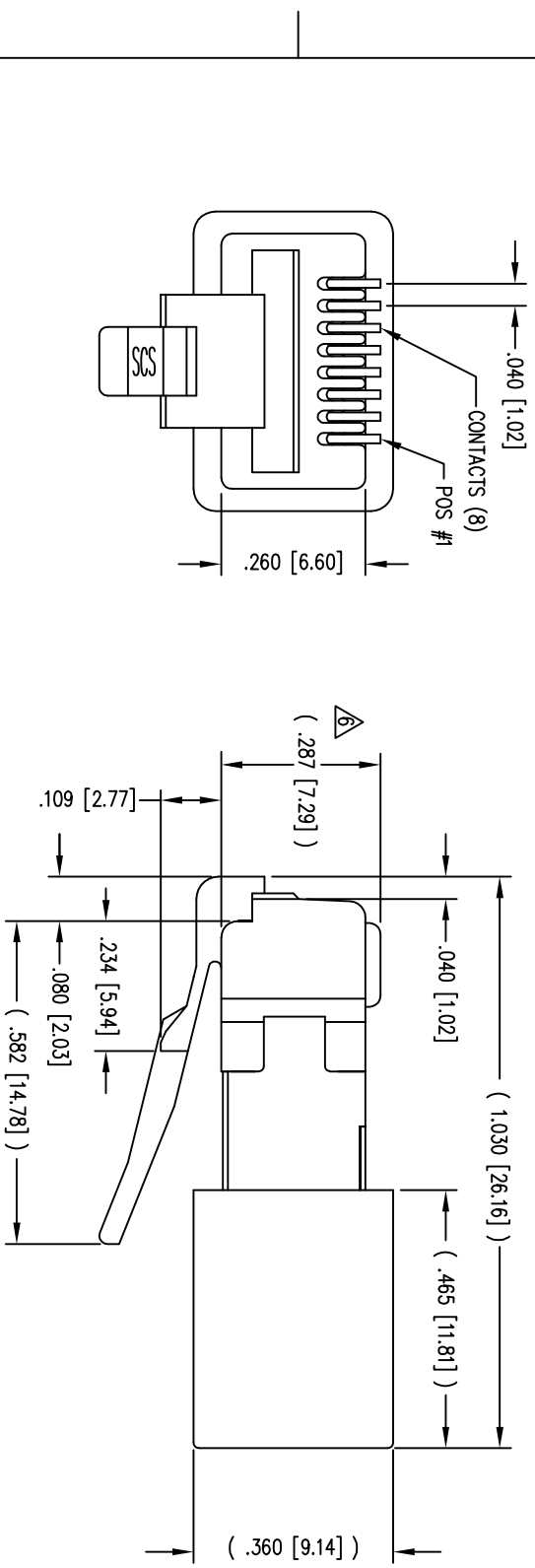

A

A

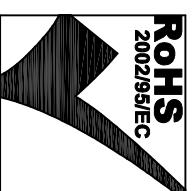
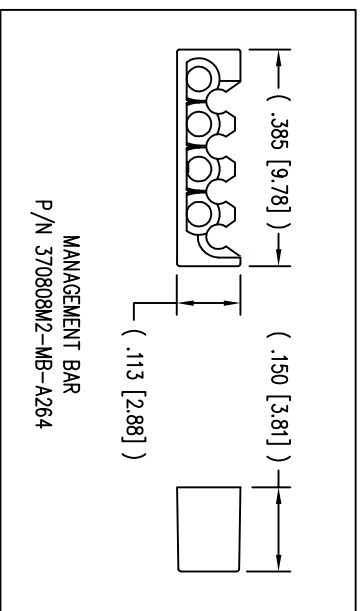
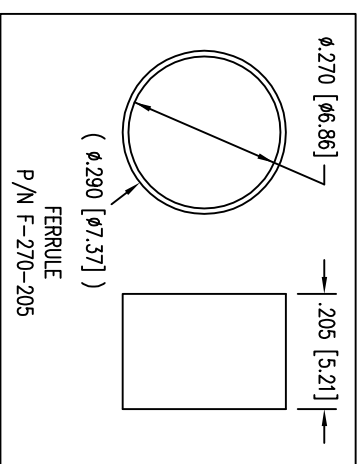
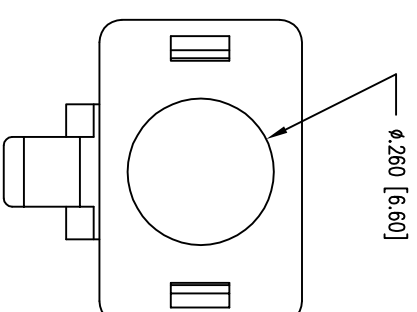

BULK	50 MICRO-INCHES [1.27um]	943-SP-370808SM2-A426
PACKAGE	CONTACT PLATING IN MATING AREA	PART NUMBER

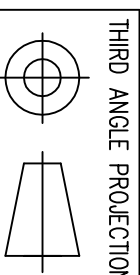

THIRD ANGLE PROJECTION
DO NOT SCALE DRAWING
DRAWING IS SUBJECT TO CHANGE WITHOUT NOTICE
DIMENSIONS: INCHES [METRIC]
UNLESS OTHERWISE SPECIFIED TOLERANCES ARE ±.005 [0.13] ANGLES ARE ± 1°

SHEET NO. 1 OF 1

Bel Stewart Connector
11118 Susquehanna Trail South
Glen Rock, PA 17327-9199
(717) 235-7512 Fax: (717) 235-7954
<http://www.stewartconnector.com>

THIS DRAWING AND THE SUBJECT MATTER SHOWN THEREON ARE CONFIDENTIAL, AND THE PROPRIETARY PROPERTY OF BEL STEWART CONNECTOR AND SHALL NOT BE REPRODUCED, COPIED, OR USED IN ANY MANNER WITHOUT PRIOR WRITTEN CONSENT OF BEL STEWART CONNECTOR. THIS PRODUCT MAY BE PROTECTED BY ONE OR MORE OF THE FOLLOWING US PATENTS:
5628847 6402559 6409533 6524728
7753717 8033863
OTHER PATENTS MAY BE PENDING.

DRN BY:	R.C.	DATE	4-20-99
APP'D BY:	D.I.	DATE	4-22-99
DWG NO.	CT370030	REV.	B5